

DL Series

Accessories



Contents

Current Probes	2
Differential Probes	3
Passive/FET/Active Probe & Accessories	4
Logic Probes and Accessories	6
DL750, DL1600 Series Accessories, Rack Mount Kit	7
High-Voltage Measurement	
Accessories, Cables	8
Adapters, Carrying Cases	9
Instrument Carts, Printer Paper, Probe Stand	10
Software	11

Current Probes For High Current and Wide Bandwidth Measurements

Yokogawa offers 4 different models of current probes to suit your various current measurement needs. Bandwidths of DC to 2, 10, 50, and 100 MHz are supported, with current measurement ranges of up to 30, 150, or 500A. Measuring current is a simple process of placing the probe clamp directly around the conductor to be measured. The current probes can be powered by the DL's probe power supply terminals. Hence, no external amplifier is required. The probes can be directly connected to the DL series instruments. Current values, in Amperes, can be directly selected via the current probe configuration menu of the DL series instruments, eliminating the usual hassle of voltage/current conversion.

701931 DC to 2 MHz, 500 A



Bandwidth: DC to 2 MHz(-3dB)
 Maximum continuous input range: 500 Arms
 Amplitude accuracy
 (0 to 500 Arms): $\pm 1.0\%$ of rdg ± 5 mV
 (to 700 Apeak): $\pm 2.0\%$ of rdg (DC, 45 to 66 Hz)
 Weight: Approx. 520 g

701930 DC to 10 MHz, 150 A



Bandwidth: DC to 10 MHz(-3dB)
 Maximum continuous input range: 150 Arms
 Amplitude accuracy
 (0 to 150 Arms): $\pm 1.0\%$ of rdg ± 1 mV
 (to 300 Apeak): $\pm 2.0\%$ of rdg (DC, 45 to 66 Hz)
 Weight: Approx. 500g

701933 DC to 50 MHz, 30 A



Bandwidth: DC to 50 MHz(-3dB)
 Maximum continuous current input range: 30 Arms
 Amplitude accuracy
 (0 to 30 Arms): $\pm 1.0\%$ of rdg ± 1 mV
 (to 50 Apeak): $\pm 2.0\%$ of rdg (DC, 45 to 66 Hz)
 Weight: Approx. 230 g

701932 DC to 100 MHz, 30 A



Bandwidth: DC to 100 MHz(-3dB)
 Maximum continuous input range: 30 Arms
 Amplitude accuracy
 (0 to 30 Arms): $\pm 1.0\%$ of rdg ± 1 mV
 (to 50 Apeak): $\pm 2.0\%$ of rdg (DC, 45 to 66 Hz)
 Weight: Approx. 240 g

- Bandwidth: DC to 2/10/50/100 MHz
- Max. Current: Max. 30/150/500 A
- Clamp Configuration Makes Current Measurements Easy
- No External Amplifier Required: Connects Directly to DL Series Instruments
- Powered by the DL's Probe Power Supply Connectors
- Current Values Can Be Read Directly on DL Series Instruments
- Includes Demagnetizing Switch and Zero Adjust Dial Functions

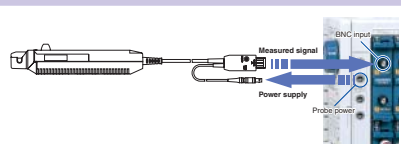

701934 Probe Power Supply

A power supply for current probes, FET probes, and differential probes. Supplies power for up to four probes, including large current probes.



Number of power supply connectors: 4
 Output voltage: ± 12 V ± 0.5 V
 Rated output current: +12 V: 2.5 A, -12 V: 2.5 A
 (the total value of four outputs)
 Rated supply voltage: AC100 to 240 V (50/60 Hz)
 External dimensions: Approx. 80 (W) * 119 (H) * 200 (D) mm
 Weight: Approx. 1.1 kg

701935 Deskew signal source



For use with the Power Supply Analysis option
 Output voltage: Approx. 0 to 5 V
 Output current: Approx. -100 to 0 mA

Current Probes

Model	Frequency bandwidth	Maximum continuous input range	Max. peak current value	Output voltage rate	Power supplies
701931	DC to 2 MHz	500 Arms	700 Apeak	0.01 V/A	Power supply cable
701930	DC to 10 MHz	150 Arms	300 Apeak	0.01 V/A	Power supply cable
701933	DC to 50 MHz	30 Arms	50 Apeak	0.1 V/A	Power supply cable
701932	DC to 100 MHz	30 Arms	50 Apeak	0.1 V/A	Power supply cable

■ See the bulletin 7019-30E for detailed specifications.

■ When using the DL to power the current probes, make sure that the total current consumption of the probes does not exceed the DL's probe power rating. See the following web site for details.

<http://www.yokogawa.com/tm/probe/>

Differential Probes For High-Voltage and High-Bandwidth Measurements

Yokogawa's differential probes let you make wide-bandwidth differential measurements. Just connect the output of the probe to the input of a single-ended digital oscilloscope. We provide you a variety of differential probes, which can be utilized for measuring the gate-to-source voltage of a switching power supply, read/write signals of a hard disk drive, high-speed logic signals, CAN bus signals, and more.

700925 Max. ±500 V/ 15 MHz

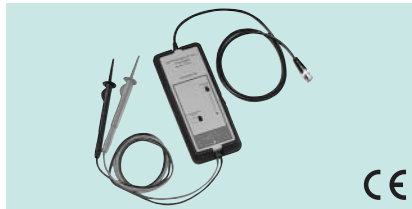

Bandwidth: DC to 15 MHz(-3dB)
 Input attenuation ratio: Switch between 1/10, 1/100
 Maximum allowed differential voltage
 : ±500 V(DC+ACpeak) or 350 Vrms (1/100)
 Maximum common mode input voltage
 : ±500 V(DC+ACpeak) or 350 Vrms(1/10, 1/100)

700924 Max. ±1400 V/ 100 MHz



Bandwidth: DC to 100 MHz(-3dB)
 Input attenuation ratio:
 Switch between 1/100 and 1/1000
 Maximum allowed differential voltage
 : ±1400 V(DC+ACpeak) or 1000 Vrms(1/1000)
 Maximum common mode input voltage
 : ±1400 V(DC+ACpeak) or 1000 Vrms(1/100, 1/1000)

701921 Max. ±700 V/ 100 MHz



Bandwidth: DC to 100 MHz(-3dB)
 Input attenuation ratio: Switch between 1/10 and 1/100
 Maximum allowed differential voltage
 : ±700 V(DC+ACpeak, 1/100)
 Maximum common mode input voltage
 : ±700 V(DC+ACpeak) (1/10, 1/100)

701922 Max. ±20 V/ 200 MHz



Bandwidth: DC to 200 MHz(-3dB)
 Input attenuation ratio: 1/10(fixed)
 Maximum allowed differential voltage: ±20 V(DC+ACpeak)
 Maximum common mode input voltage: ±60 V(DC+ACpeak)
 50 Ω output

701920 Max. ±12 V/ 500 MHz

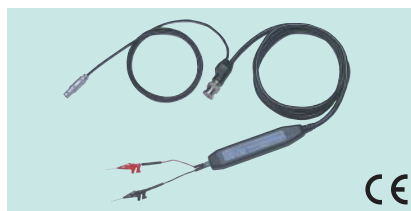

Bandwidth: DC to 500 MHz(-3dB)
 Input attenuation ratio: 1/10(fixed)
 Input impedance: 100 KΩ /2.5 pF
 Maximum allowed differential voltage: ±12 V(DC+ACpeak)
 Maximum common mode input voltage: ±30 V(DC+ACpeak)
 50 Ω output

701923 Max. ±5 V/ 2 GHz



Bandwidth: DC to 2 GHz
 Input attenuation ratio: 1/10(with 50 Ω input)
 Maximum allowed differential voltage: ±5 V
 Maximum common mode input voltage: ±7 V
 Input impedance: 50 kΩ //Approx. 1.1 pF

B9852MJ

Power cable



The B9852MJ cable supplies power to the 700924, 700925 and 701921 differential probes* from the DL probe power connectors. (The probe power option is required on the DL unit.)

700976

50 Ω terminator



Used to connect an oscilloscope having a 1 MΩ input to a probe with a 50 Ω output. It is required when using the 701920 and 701922 probes with the DL1600 series.

* Cable only works with newer 700924, 700925 and 701921 probes that indicate "6 VDC or 9 VDC" at the probe input power connector.

Differential Probe Selection Guide

Model	Frequency bandwidth	Attenuation Ratio	Maximum allowed differential voltage	Maximum input voltage	Power supplies	Application
700924	DC to 100 MHz(-3dB)	1/100, 1/1000	±1400 V(DC+ACpeak)	±1400 V(DC+ACpeak)	AA batteries or B9852MJ Power cable* *: sold separately	For High voltage measurement •High voltage(+/-1400 V) can be measured safely •Useful for evaluating high-frequency inverter circuits (e.g., IGBT) •High common mode input voltage
701921	DC to 100 MHz(-3dB)	1/10, 1/100	±700 V(DC+ACpeak)	±1000 V(DC+ACpeak)	AA batteries or B9852MJ Power cable* *: standard accessory	For High and medium voltage measurement •Useful for high and medium voltage differential measurements •1/10, 1/100 (switchable)
700925	DC to 15 MHz(-3dB)	1/10, 1/100	±500 V(DC+ACpeak)	±1000 V(DC+ACpeak)	AA batteries or B9852MJ Power cable* *: sold separately	For medium voltage measurement
701922	DC to 200 MHz(-3dB)	1/10 (fixed)	±20 V(DC+ACpeak)	±60 V(DC+ACpeak)	Power supply cable	For medium speed signal measurement •For CAN bus signal measurement •Sensor signal measurement for automobile development
701920	DC to 500 MHz(-3dB)	1/10 (fixed)	±12 V(DC+ACpeak)	±40 V(DC+ACpeak)	Power supply cable	For high speed signal measurement •For high speed differential measurement such as LVDS •For measuring signals floating from ground in a high-speed digital circuit •Input capacity : 2.5 pF
701923	DC to 2.0 GHz(-3dB)	1/10 (fixed)	±5 V(DC+ACpeak)	±25 V(DC+ACpeak)	DL9000 probe I/F	•For high speed differential measurement such as LVDS •System measurements up to 1.5 GHz BW with DL9200

■The max. current consumption of all the above differential probes is ±125 mA. Make sure that the total current consumption of the probes does not exceed the DL's probe power rating.
 ■See the following web site for details. <http://www.yokogawa.com/tm/probe/>

Passive Probes, FET Probe and Active Probes

Using an active probe or FET probe is an effective way to measure high speed signals. Even when using a passive probe, you can effectively reproduce waveforms with less ringing or overshoot by devising different ways to connect to ground. In addition to a variety of passive probes, Yokogawa offers a library of miniature probes, high voltage probes, FET probes, and active probes.

700960

200 MHz Passive Probe



For the DL1600 series
1.5 m long

700988

400 MHz Passive Probe



For the DL1700E, 7400 series
1.5 m long
Standard accessories include:
Ground lead, Pinchers tip, IC test tip, Ground attachment, Marker tip

701943

500 MHz Passive Probe



For the DL9000 series
1.5 m long
Standard accessories include:
Ground lead, Pinchers tip, IC test tip, Ground attachment, Marker tip

701941/42

Miniature passive probe



For DL1700E, 7400 series
1.2 m long (701941), 3.0 m long (701942)
Bandwidth: 500 MHz (701941), 350 MHz (701942)

701940

10:1 Passive Probe for DL750



For the DL750/P and SL1400 module
1.5 m long
Standard accessories include:
Ground lead, Pinchers tip, IC test tip, Ground attachment, Marker tip

700929

10:1 probe (Safety probe - for use with isolated input modules)



For the DL750/P and SL1400 isolation modules
1.5 m long

701944/45

100:1 High voltage probe



1.2 m long (701944), 3.0 m long (701945)
Bandwidth: 400 MHz (701944), 250 MHz (701945)

701974

5 GHz Low capacitance probe

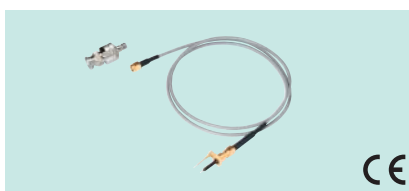

Connector type: SMA
Input resistance: 450 Ω/1 kΩ
Input capacitance: 0.25 pF/0.4 pF

701912/13/14

Active probe



Bandwidth: 1.0 GHz (701912)
1.5 GHz (701914)
2.5 GHz (701913)

700939

FET probe



Bandwidth: DC to 900 MHz
1.5 m long
50 Ω output

B9852CR

Mini clip converter

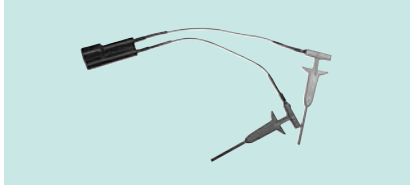

A clip set designed for the 700988, 700960 and 701940 probes.

700971

Mini clip converter



A clip set designed for 701943 (PB500) and 700939

700972

BNC adapter



For 701943 (PBA500) and 700939

366945

Printed circuit board adapter

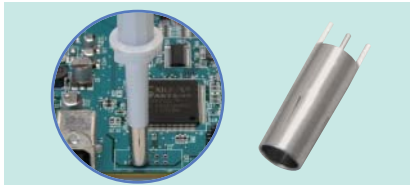

For 701943 (PB500) and 700939
Order Q'ty: 10 (1 set)

366946

Solder-in adapter

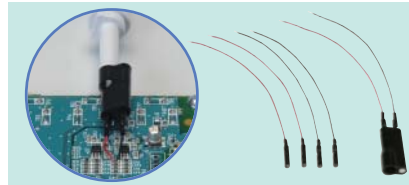

For 701943 (PB500) and 700939
Standard accessories include: Adapter, red wire (3), black wire (3)

B9852HF

Basic accessories set for the 701941 probe

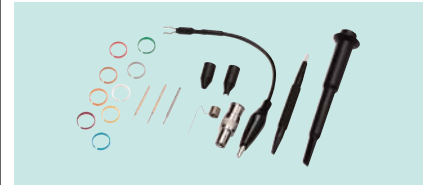

11 accessories have been included in this set
(See below *1).

Passive Probe Selection Guide

Model	Frequency Bandwidth	Attenuation Ratio	Maximum Input Voltage	Input Resistance/Capacitance ^(*)	Compensation Range ^(*)	Cable Length
700960	DC to 200 MHz(- 3dB, 1/10)	1/1 or 1/10	600 V(DC+ACpeak)	10 MΩ/14 pF(1/10)	14- 30 pF	1.5 m
700988	DC to 400 MHz(- 3dB, 1/10)	1/1 or 1/10	600 V(DC+ACpeak)	10 MΩ/14 pF(1/10)	15- 25 pF	1.5 m
701943	DC to 500 MHz(- 3dB)	1/10 (fixed)	600 V(DC+ACpeak)	10 MΩ/14 pF(1/10)	15- 25 pF	1.5 m
701941	DC to 500 MHz(- 3dB)	1/10 (fixed)	400 Vrms	10 MΩ/10 pF	10- 25 pF	1.2 m
701942	DC to 350 MHz(- 3dB)	1/10 (fixed)	400 Vrms	10 MΩ/18 pF	7- 25 pF	3 m
701940	DC to 10 MHz(- 3dB, 1/10)	1/1 or 1/10	600 V(DC+ACpeak, nonisolated input)	10 MΩ/22 pF(1/10)	17- 46 pF	1.5 m
700929	DC to 100 MHz(- 3dB)	1/10 (fixed)	1000 V(DC+ACpeak, probe itself)	10 MΩ/18 pF	20- 45 pF	1.5 m
701944	DC to 400 MHz(- 3dB)	1/100 (fixed)	1000 Vrms	50 MΩ/7.5 pF	10-50 pF	1.2 m
701945	DC to 250 MHz(- 3dB)	1/100 (fixed)	1000 Vrms	50 MΩ/7.5 pF	10-50 pF	3 m
701974	DC to 5 GHz(- 3dB, 1/10)	1/10, 1/20	20 Vrms, 40 VACpeak	500 Ω/0.25 pF, 1 kΩ/0.4 pF	—	1.1 m
701912	DC to 1.0 GHz(- 3dB)	1/10 (fixed)	±7 V	100 kΩ/0.9 pF	—	1.2 m
701914	DC to 1.5 GHz(- 3dB)	1/10 (fixed)	±7 V	100 kΩ/0.9 pF	—	1.2 m
701913	DC to 2.5 GHz(- 3dB)	1/10 (fixed)	±7 V	100 kΩ/0.9 pF	—	1.2 m
700939	DC to 900 MHz(- 3dB)	1/10 (fixed)	10 V(DC+ACpeak)	2.5 MΩ/1.8 pF	—	1.5 m

*1: The B9852HF contains the following eleven(11) kinds of accessories.

(Insulation cap, IC cap, BNC adapter, Rigid tip, Spring tip (Ø: 0.80 mm), Spring tip (Ø: 0.38 mm), Ground spring, Adjustment tool, Pincher tip, Standard ground lead, Color coding rings)

*2: Input Capacitance: Capacitance at the tip of the probe

Compensation Range: Compensation Range for the input capacitance of the oscilloscope

See the following web site for details of these passive probes. <http://www.yokogawa.com/tm/probe/>

Logic Probes and Accessories

The DL7400 and DL9700 series let you simultaneously observe multiple signals from analog and logic mixed circuits, in a single instrument. In addition to up to 16 channels of analog inputs, the DL750, DL750P, and SL1400 allow you to observe 16 bit logic signals simultaneously. The following four types of logic probes can be used with these instruments.

701980

Logic Probe for DL7400 and DL9700



Maximum toggle frequency: 100 MHz
Input impedance (typical value): 1 M Ω /10 pF

701981

Logic Probe for DL7400 and DL9700



Maximum toggle frequency: 250 MHz
Input impedance (typical value): 10 k Ω /9 pF

700986

Logic probe for the DL750/P and SL1400



Non-isolated input
Two Measurement leads(B9879PX and B9879KX) included.

700987

Logic Probe for the DL750/P and SL1400



Isolated input
Use with measurement lead 758917 and 758922, 758929 or 701954 adapter leads (below). 701954 is shown on page 8.

B9852ES

IC Clip

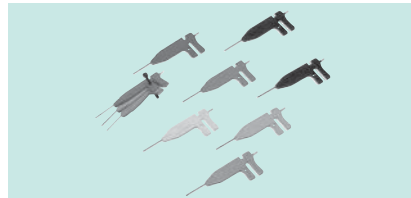

Attached to the tips of logic probe (701980 or 701981) or mini-clips (B9852CR), the IC clips can be used to clip contiguous 0.5-mm pitch terminals. A total of 10 clips are included.

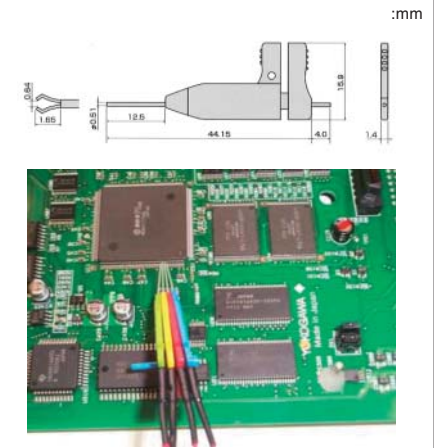

Combination

Combination

758917

Measurement lead set



A set of 0.8 m long red and black test leads, used in combination with a pair of optional 758922 or 758929 alligator-clip adapters.

758922

Small Alligator-clip Adapter

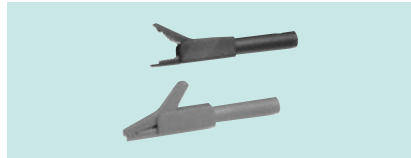

Rated at 300 V. Attaches to the 758917 test leads. Sold in pairs.

758929

Large Alligator-clip Adapter



Rated at 300 V. Attaches to the 758917 test leads. Sold in pairs.

Logic Probe Selection Guide

Model	Inputs	Nondestructive Input Voltage Range	Input Impedance	Input Voltage Range	Threshold Level	External Dimensions
701980	8	± 10 V	1 M Ω /10 pF	± 40 V (DC +ACpeak)	± 10 V at 0.1 V resolution	85.7 mm * 64.2 mm * 20 mm
701981	8	± 10 V	10 k Ω /9 pF	± 40 V (DC +ACpeak)	± 10 V at 0.1 V resolution	85.7 mm * 64.2 mm * 20 mm
700986	8	± 42 V (DC +ACpeak)	Approx. 100 k Ω	± 42 V (DC +ACpeak)	1.4 V	150 mm * 60 mm * 20 mm
700987	8	DC input: H/L detection for 10 V DC to 250 VDC AC input: H/L detection (50/60 Hz) for 80 V AC to 250 VAC	Approx. 100 k Ω	250 Vrms(CAT I , CAT II)	DC input 6 VDC $\pm 50\%$ AC input 50 VAC $\pm 50\%$	195 mm * 117.3 mm * 45 mm

DL750 · DL750P · SL1400 Accessories

701955·701956

NDIS Bridge Heads



NDIS cable(5 m) included
Bridge resistance: 120 Ω (701955)
350 Ω (701956)

701957·701958

D-sub Bridge Heads



D-sub cable(5 m) included
Supports Shunt-Cal
Bridge resistance: 120 Ω (701957)
350 Ω (701958)

700940

NDIS Connector Cable



A 1.5 m long connector-to-connector
adapter cable complying with NDIS-MIL
C26482. Used to connect a MIL-stand-
ard cable to the strain module

A1002JC

NDIS Connector



An NDIS connector for direct connec-
tion to a
strain module.

701951

Earphone microphone



For recording and playing voice memos

701952

Speaker cable



For playing voice memos

701970

DC power cord



For the DC power supply model (/DC).
Cigarette lighter plug type
1.8 m long

701971

DC power cord



For the DC power supply model (/DC).
Alligator clip type
1.8 m long

DL1600 Series Accessories

701680

Battery Box (only works with - DC model)



Powers instrument for approx. 2 hours
Charging time: approx. 4.5 hours
Max. Power consumption: 200 VA

B8050WP

Battery box connection cable



For connection between DL1640 Series and 701680.
Comes standard with the 701680 battery box.

A1105JC

DC power supply connector



For the DC power supply model (-DC).

Rack Mount Kit

701965

Rack mount kit for DL7400 series (for EIA rack)

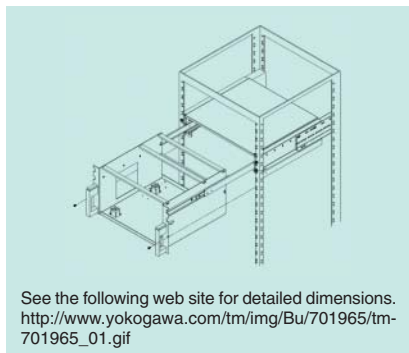

See the following web site for detailed dimensions.
http://www.yokogawa.com/tm/img/Bu/701965/tm-701965_01.gif

701984-01

Rack mount kit for DL9000 series (for EIA rack)

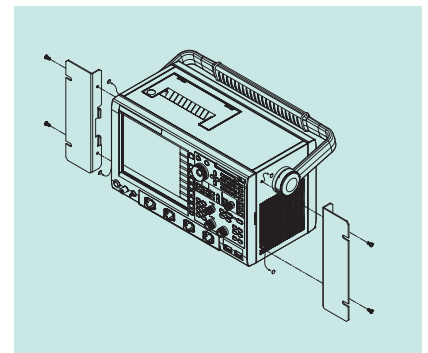

High-Voltage Measurement Accessories

These accessories enable safe high-voltage measurements when used together with DL750, DL750P and SL1400 isolated input modules. [Note: read the User's Manual carefully before making high-voltage measurements]

700929

Isolation Probe



Use with DL750/P and SL1400 isolation modules For High-voltage measurements
1.5 m long

701901

1:1 BNC safety adapter cable

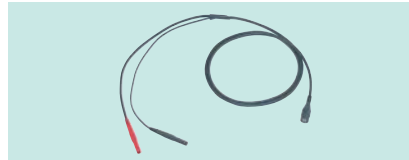

1000 Vrms-CAT II, 1.8 m long
Safety BNC(male) to safety banana(female) use in combination with 701959, 701954, 758921, 758922 or 758929

701902-701903

Safety BNC cable



701902:
1000 Vrms-CAT II (BNC-BNC), 1 m
701903:
1000 Vrms-CAT II (BNC-BNC), 2 m

Small-sized

Large-sized

Combination

For screw terminal

701959

Safety Mini clip(Hook Type)



Set contains one black and one red clip.
1000 Vrms-CAT II
It can be connected with 701901.

701954

Alligator clip(Dolphin type)



Set contains one black and one red clip.
1000 Vrms-CAT II

758921

Fork terminal adapter



Adapters for fitting a 4mm banana plug to a fork terminal. Set contains one black and one red clip.
1000 Vrms-CAT II

Cables

366924-366925

BNC cable



A 1 m long (366924) and 2 m long (366925) BNC-BNC cables.
Use only for circuits having voltage levels no greater than 42 V.

366926

BNC cable



A 1 m long BNC-alligator clip cable.
Use only for circuits having voltage levels no greater than 42 V.

366973

Go/No-Go Cable



Do not use this cable for purposes other than DL750/1600/1700/7400 GO/NO-GO judgement.
Used to connect an external device.

Color	Pin No.	Signal Name	Logic
Yellow	2	START IN	Negative
White	3	GO OUT	Negative
Green	4	NOGO OUT	Negative
Blue	5	GND	

366961

Measurement cable



A subassembly of 1.2 m long test leads with alligator-clip adapters.
Use only for circuits having voltage levels no greater than 42 V.

Adapters

366921

Conversion Adapter



BNC-Banana-jack (female) adapter. Use for circuits having voltage levels no greater than 42 V.

366922

Conversion Adapter



Banana-plug (male)-BNC adapter. Use for circuits having voltage levels no greater than 42 V.

366923

T-Adapter



T-adapter for BNC connectors. Use for circuits having voltage levels no greater than 42 V.

751512

Conversion Adapter



Safety-terminal-binding-post adapter. Use for circuits having voltage levels no greater than 42 V.

700976

50 Ω terminator



Used to connect an oscilloscope having a 1 MΩ input to a probe with a 50-ohm output. Frequency range: DC-500 MHz. Allowable power: 0.5 W.

366928

Conversion Adapter



A BNC (jack)-RCA (plug) adapter. Use for circuits having voltage levels no greater than 42 V.

758924

BNC Adapter



An adapter for fitting a 4 mm wide banana plug to a BNC connector (male).

Carrying Cases

701964

Soft Carrying Case for DL1600/ DL1700E series



Three pockets are provided for storing accessories and the user's manual. Can store the DC power supply model and the Battery box.

701950

Hard Carrying Case for DL1600/ DL1700E series



Hard type carrying case.

700914

Soft Carrying Case for DL1700E series.



Soft type carrying case.

701963

Soft Carrying Case for DL750/ DL9200



Three pockets are provided for storing accessories and the user's manual.

701967

Soft Carrying Case for DL750P/ SL1400



Three pockets are provided for storing accessories.

Instrument Carts

We offer compact, deluxe and all-purpose instrument cars to meet your needs.

701960

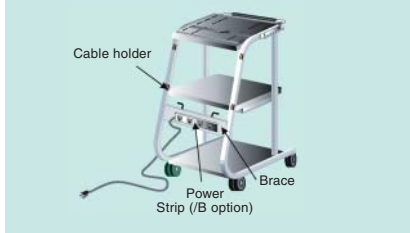

Compact Instrument Cart
500 mm (W) × 560 mm (D) × 705 mm (H)
/A option: keyboard, mouse table
/B option: comes with a 3-prong power strip

Specifications

Upper shelf angle:
Horizontal or approximately 18°
Outer (maximum) dimensions:
500 mm (W) × 560 mm (D) × 705 mm (H)
Upper shelf dimensions:
450 mm (W) × 450 mm (D) × 25 mm (H)
Middle/lower shelf dimensions:
450 mm (W) × 450 mm (D) × 25 mm (H)
Space between middle and upper shelves: 300 mm
Space between middle and lower shelves: 240 mm
(without accessory tray)
Maximum load (per shelf): 20 kg
Cart weight: 21 kg

701961

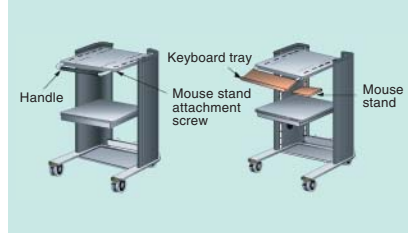

Deluxe Instrument Cart
570 mm (W) × 580 mm (D) × 839 mm (H)
/A option: keyboard, mouse table
/B option: comes with a 3-prong power strip

Specifications

Shelf position:
Adjustable to any position using screw holes
Outer (maximum) dimensions:
570 mm (W) × 580 mm (D) × 839 mm (H)
Upper shelf dimensions:
450 mm (W) × 450 mm (D) × 35 mm (H)
Lower shelf dimensions:
450 mm (W) × 450 mm (D) × 35 mm (H)
Space between upper and lower shelves:
Depends on position of shelves
Maximum load (per shelf): 50 kg
Cart weight: 25 kg

701962

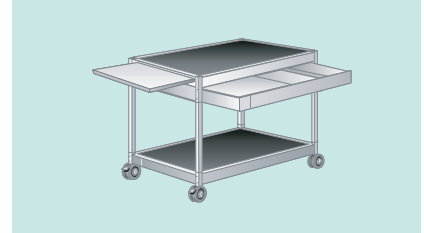

All-Purpose Instrument Cart
467 mm (W) × 693 mm (D) × 713 mm (H)

Specifications

Outer (maximum) dimensions:
467 mm (W) × 693 mm (D) × 713 mm (H)
Upper/lower shelf dimensions:
457 mm (W) × 683 mm (D)
Drawer:
610 mm (W) × 380 mm (D)
Slide-out table:
380 mm (W) × 440 mm (D)
Casters:
100 mm diameter wheels (front casters with stoppers)
Maximum load (per shelf): 50 kg
Cart weight: 23.5 kg

Printer Paper

B9850NX

DL Printer Paper



For the DL1600, DL1700E, DL7400 series
Paper width: 112 mm
Paper length: 30 m
Order Q'ty: 5 (1set)

B9988AE

DL Printer Paper



For the DL750, DL9000 series
Paper width: 112 mm
Paper length: 10 m
Order Q'ty: 10 (1set)

701966

DL Printer Paper



For the DL750P, SL1400
Paper width: 210 mm
Paper length: 20 m
Order Q'ty: 6 (1set)

Probe Stand

701919

Probe Stand



Diameter of attachable probe: ø8 to 13 mm
Weight: Approx. 1.5 kg

Software

701992

Xviewer

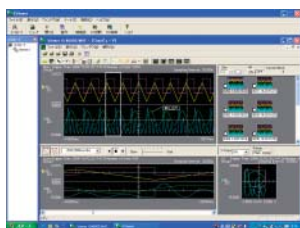

Xviewer allows you to view and analyze waveform data that has been obtained and saved using either the DL series.

700919

Waveform Viewer for DL series

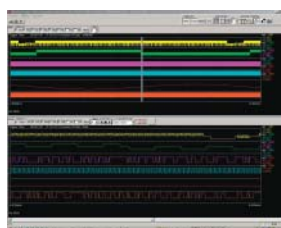

Waveform Viewer lets you view waveforms on your PC, just as you view them on the DL Series instrument.

Wirepuller

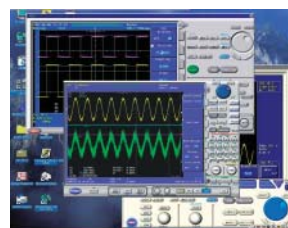

Wirepuller displays an image of the front panel DL Series on your PC for monitoring waveform signals. You control the DL Series by simply using your PC's mouse and keyboard to perform actions on the displayed front panel.

701991

MATLAB tool kit

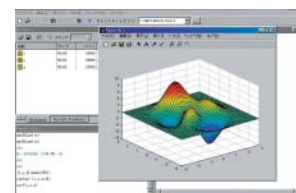

The MATLAB tool kit for DL series is a plug-in for MATALAB software. The toolkit can be used to control supported DL series instruments using MATLAB or to acquire data from the DL series for use in MATLAB via a communication interface (GP-IB, USB, Ethernet).

Visit the following web sites for details about this software:

1. 701992 XViewer
<http://www.yokogawa.com/tm/701992/>
2. 700919 Waveform Viewer for DL series
<http://www.yokogawa.com/tm/700919/>
3. Wirepuller
<http://www.yokogawa.com/tm/wirepuller/>
4. MATLAB tool kit
<http://www.yokogawa.com/tm/701991/>

Model Numbers and Suffix Codes

■ Current Probes

Product	Model Name	Description	Order Q'ty
Current Probe	701931	DC to 2 MHz	1
Current Probe	701930	DC to 10 MHz	1
Current Probe	701933	DC to 50 MHz	1
Current Probe	701932	DC to 100 MHz	1
Power supply	701934	Number of connectors : 4	1
Deskew signal source	701935	For Power Supply Analysis option	1

■ Differential Probes

Product	Model Name	Description	Order Q'ty
Differential Probe	700924	Max. ± 1400 V/ 100 MHz	1
Differential Probe	701921	Max. ± 700 V/ 100 MHz	1
Differential Probe	700925	Max. ± 500 V/ 15 MHz	1
Differential Probe	701922	Max. ± 20 V/ 200 MHz	1
Differential Probe	701920	Max. ± 12 V/ 500 MHz	1
Differential Probe	701923	Max. ± 5 V/ 2 GHz	1
Power cable	B9852MJ	Supplies power to the DL unit	1

■ Passive Probes, FET Probe and Active Probes

Product	Model Name	Description	Order Q'ty
Passive Probe	700960	200 MHz bandwidth, 600 V	1
Passive Probe	700988	400 MHz bandwidth, 600 V	1
Passive Probe	701943	500 MHz bandwidth, 600 V	1
Miniature passive probe	701941	500 MHz bandwidth, 400 Vrms, 1.2 m	1
Miniature passive probe	701942	350 MHz bandwidth, 400 Vrms, 3.0 m	1
Passive Probe	701940	10 MHz bandwidth, 600 V	1
10:1 probe	700929	100 MHz bandwidth isolation probe	1
High voltage probe	701944	400 MHz bandwidth, 1,000 Vrms, 1.2 m	1
High voltage probe	701945	250 MHz bandwidth, 1,000 Vrms, 3.0 m	1
Low capacitance probe	701974	5 GHz bandwidth, 500/1 k Ω input impedance	1
Active probe	701912	1.0 GHz bandwidth, 7 V	1
Active probe	701914	1.5 GHz bandwidth, 7 V	1
Active probe	701913	2.5 GHz bandwidth, 7 V	1
FET probe	700939	900 MHz bandwidth, 10 V	1
Mini clip converter	B9852CR	For 700988/700960/701940 probes	1
Mini clip converter	700971	For 701943 and 700939	1
BNC Adapter	700972	For 701943 and 700939	1
Printed circuit board adapter	366945	For 701943 and 700939	10(1set)
Solder-in adapter	366946	For 701943 and 700939	1
Basic accessories set for the 701941 probe	B9852HF	11 accessories have been included	1

■ Logic Probes

Product	Model Name	Description	Order Q'ty
Logic Probe	701980	Maximum toggle frequency : 100 MHz	1
Logic Probe	701981	Maximum toggle frequency : 250 MHz	1
Logic Probe	700986	For DL750/P and SL non-isolated input	1
Logic Probe	700987	For DL750/P and SL isolated inputs	1
IC Clip	B9852ES	For contiguous 0.5-mm pitch terminals	1
Measurement lead set	758917	For 700987 Isolated logic probe	1
Small Alligator-clip Adapter	758922	300 Vrms-CAT II	1
Large Alligator-clip Adapter	758929	1000 Vrms CAT II	1

DL750/P • SL1400 Accessories

Product	Model Name	Description	Order Q'ty
Bridge Head	701955	NDIS cable(5 m) included, 120 Ω	1
Bridge Head	701956	NDIS cable(5 m) included, 350 Ω	1
Bridge Head	701957	D-sub cable(5 m) included, 120 Ω	1
Bridge Head	701958	D-sub cable(5 m) included, 350 Ω	1
NDIS Connector Cable	700940	NDIS-MIL conversion, 1.5 m long	1
NDIS Connector	A1002JC	For the Strain module	1
Earphone microphone	701951	For recording and playing voice memos	1
Speaker cable	701952	For playing voice memos	1
DC power cord	701970	Cigarette lighter plug type	1
DC power cord	701971	Alligator clip type	1

DL1600 Series Accessories

Product	Model Name	Description	Order Q'ty
Battery Box	701680	For DL1600 series	1
Battery box connection cable	B8050WP	For connection between DL1640 Series and 701680	1
DC power supply connector	A1105JC	For the DL1640 Series DC power supply model (-DC).	1

Rack mount kit

Product	Model Name	Description	Order Q'ty
Rack mount kit	701965	For DL7400 series (for EIA rack)	1
Rack mount kit	701984	For DL9000 (for EIA rack)	1

High-Voltage Measurement Accessories

Product	Model Name	Description	Order Q'ty
Isolation Probe	700929	For DL750/P and SL isolation module	1
1:1 BNC safety adapter cable	701901	1000 Vrms-CAT II, A1.8 m long	1
Safety Mini clip(Hook Type)	701959	A set of brack and red clip, 1000 Vrms-CAT II	1
Alligator clip(Dolphin type)	701954	A set of brack and red clip, 1000 Vrms-CAT II	1
Fork terminal adapter	758921	A set of brack and red clip, 1000 Vrms-CAT II	1
Safety BNC cable	701902	1000 Vrms, 1 m long	1
Safety BNC cable	701903	1000 Vrms, 2 m long	1

Cables

Product	Model Name	Description	Order Q'ty
BNC cable	366924	1 m long	1
BNC cable	366925	2 m long	1
BNC cable	366926	A 1 m long BNC-alligator clip cable	1
GO/NO-GO Cable	366973	For GO/NO-GO judgement.	1
Measurement cable	366961	A subassembly of 1.2 m long test leads with alligator-clip adapters	1

Adapters

Product	Model Name	Description	Order Q'ty
Conversion Adapter	366921	BNC-Banana-jack (female) adapter	1
Conversion Adapter	366922	Banana-plug (male)-BNC adapter	1
T-Adapter	366923	T-adapter for BNC connectors	1
Conversion Adapter	751512	Safety terminal-binding post adapter	1
50 Ω terminator	700976	Feed-through type	1
Conversion Adapter	366928	A BNC (jack)-RCA (plug) adapter	1
BNC Adapter	758924	BNC-banana jack(female) adapter	1

Carrying Cases

Product	Model Name	Description	Order Q'ty
Soft Carrying Case	701964	For the DL1600/DL1700E series	1
Hard Carrying Case	701950	For the DL1600/DL1700E series	1
Soft Carrying Case	700914	For the DL1700E series	1
Soft Carrying Case	701963	For the DL750/DL9200	1
Soft Carrying Case	701967	For the DL750P, SL1400	1

Instrument Carts

Product	Model Name	Description	Order Q'ty
Instrument Cart	701960	Compact Instrument Cart	1
	/A	keyboard, mouse table	
	/B	3-prong power strip	
Instrument Cart	701961	Deluxe Instrument Cart	1
	/A	keyboard, mouse table	
	/B	3-prong power strip	
Instrument Cart	701962	All-Purpose Instrument Cart	1

Printer Paper

Product	Model Name	Description	Order Q'ty
Printer paper	B9850NX	For the DL1600, DL1700E, DL7400	5(1set)
Printer paper	B9988AE	For the DL750, DL9000	10(1set)
Printer paper	701966	For the DL750P, SL1400	6(1set)

Probe stand

Product	Model Name	Description	Order Q'ty
Probe stand	701919	Attachable probe: ø8 to 13 mm	1

Software

Product	Model Name	Description	Order Q'ty
Xviewer	701992-SP01	1 License	1
Xviewer	701992-GP01	Math function 1 license	1
Waveform Viewer for DL series	700919	For the DL1600, DL1700E, DL7400 series	1
Wirepuller	-	Free Software	-
MATLAB tool kit	701991	plug in software for the MATLAB	1

Front Panel Protective Covers

Product	Model Name	Description	Order Q'ty
Front Panel Protective Cover	B9989FA	A transparent cover for the DL1700E/1600	1
Front Panel Protective Cover	B8023EA	A transparent cover for the DL750	1
Front Panel Protective Cover	B8051DP	A transparent cover for the DL7400	1
Front Panel Protective Cover	B8080EM	A transparent cover for the DL9000	1

Soft Case

Product	Model Name	Description	Order Q'ty
Soft Case	B9918EZ	For the DL1600,1700E series	1
Soft Case	B9946EB	For the DL750/P and SL1400	1
Soft Case	B9969ET	For the DL7400 series	1
Soft Case	B8080FQ	For the DL9000 series	1

* Microsoft, Windows are trademarks or registered trademarks of Microsoft Corporation in the US and other countries.

* MATLAB is a registered trademark of the Math Works, Inc in the US.

YOKOGAWA

YOKOGAWA ELECTRIC CORPORATION

Communication & Measurement Business Headquarters /Phone: (81)-422-52-6768, Fax: (81)-422-52-6624

E-mail: tm@cs.jp.yokogawa.com

YOKOGAWA CORPORATION OF AMERICA

Phone: (1)-770-253-7000, Fax: (1)-770-251-6427

YOKOGAWA EUROPE B.V.

Phone: (31)-33-4641858, Fax: (31)-33-4641859

YOKOGAWA ENGINEERING ASIA PTE. LTD.

Phone: (65)-62419933, Fax: (65)-62412606

Subject to change without notice.

[Ed : 05/b] Copyright ©2004

Printed in Japan, 707(KP)

MS-16E